

WARNING

"Maintenance interval depends on the usage and riding circumstances. Clean regularly the chain with an appropriate chaincleaner. Never use alkali based or acid based solvents such as rust cleaners. If those solvent be used chain might break and cause serious injury."

• In order to obtain good gear shifting performance, this chain has a forward side and a reverse side, and the sides are marked so that the chain will face the correct way when installed. The proper design performance will be obtained when the chain is installed so that it faces the correct way. If it is installed so that it faces the opposite way, the chain may come off and the bicycle may fall over and serious injury may occur as a result.

• Check that the wheels are fastened securely before riding the bicycle. If the wheels are loose in any way, they may come off the bicycle and serious injury may result.

• Use the reinforced connecting pin only for connecting the narrow type of chain.

• If connecting pins other than reinforced connecting pins are used, or if a reinforced connecting pin or tool which is not suitable for the type of chain is used, sufficient connection force may not be obtained, which could cause the chain to break or fall off.

• If it is necessary to adjust the length of the chain due to a change in the number of sprocket teeth, make the cut at some other place than the place where the chain has been joined using a reinforced connecting pin. The chain will be damaged if it is cut at a place where it has been joined with a reinforced connecting pin.

• Check that the tension of the chain is correct and that the chain is not damaged. If the tension is too weak or the chain is damaged, the chain should be replaced. If this is not done, the chain may break and cause serious injury.

• Obtain and read the service instructions carefully prior to installing the parts. Loose, worn or damaged parts may cause the bicycle to fall over and serious injury may occur as a result. We strongly recommend only using genuine Shimano replacement parts.

• Obtain and read the service instructions carefully prior to installing the parts. If adjustments are not carried out correctly, the chain may come off and this may cause you to fall off the bicycle which could result in serious injury.

• Read these Technical Service Instructions carefully, and keep them in a safe place for later reference.

Chain	Reinforced connecting pin	Chain tool
10-speed super narrow chain for MTB	with groove (3) with groove (2)	TL-CN32 TL-CN23 TL-CN27

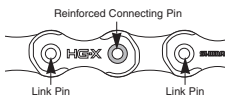

Note

- If gear shifting operations do not feel smooth, wash the derailleur and lubricate all moving parts.
- If the amount of looseness in the links is so great that adjustment is not possible, you should replace the derailleur.
- You should periodically clean the derailleur and lubricate all moving parts (mechanism and pulleys).
- If gear shifting adjustment cannot be carried out, check the degree of parallelism at the rear end of the bicycle. Also check if the cable is lubricated and if the outer casing is too long or too short.
- If you hear abnormal noise as a result of looseness in a pulley, you should replace the pulley.
- If the wheel becomes stiff and difficult to turn, you should lubricate it with grease.
- Do not apply any oil to the inside of the hub, otherwise the grease will come out.
- You should periodically wash the sprockets in a neutral detergent and then lubricate them again. In addition, cleaning the chain with neutral detergent and lubricating it can be an effective way of extending the useful life of the sprockets and the chain.
- If the chain keeps coming off the sprockets during use, replace the sprockets and the chain.
- Use a frame with internal cable routing is strongly discouraged as it has tendencies to impair the SIS shifting function due to its high cable resistance.
- Always be sure to use the sprocket set bearing the same group marks. Never use in combination with a sprocket bearing a different group mark.
- Use an outer casing which still has some length to spare even when the handlebars are turned all the way to both sides. Furthermore, check that the shifting lever does not touch the bicycle frame when the handlebars are turned all the way.
- A special grease is used for the gear shifting cable. Do not use DURA-ACE grease or other types of grease, otherwise they may cause deterioration in gear shifting performance.
- Grease the inner cable and the inside of the outer casing before use to ensure that they slide properly.
- For smooth operation, use the specified outer casing and the bottom bracket cable guide.
- Operation of the levers related to gear shifting should be made only when the front chainwheel is turning.
- If the brake fluid used in the oil disc brakes is of a type which tends to adhere to the plastic parts of the shifting lever, this may cause the plastic parts to crack or become discolored. Therefore, you should make sure that the brake fluid does not adhere to these plastic parts.
- The mineral oil which is used in SHIMANO disc brakes does not cause cracking or discoloration if it adheres to plastic parts, but such parts should be cleaned with alcohol beforehand to prevent foreign particles from adhering.
- Do not disassemble the indicator and shifting lever unit, as this may damage them or cause mis-operation.
- Parts are not guaranteed against natural wear or deterioration resulting from normal use.
- For maximum performance we highly recommend Shimano lubricants and maintenance products
- For any questions regarding methods of installation, adjustment, maintenance or operation, please contact a professional bicycle dealer.



Technical Service Instructions

SI-6TARA-001

Rear Drive System

In order to realize the best performance, we recommend that the following combination be used.

Series	XT
RAPIDFIRE (Shifting lever)	SL-M770-10
Outer casing	OT-SP41 (SIS-SP41)
Rear derailleur	RD-M773
Type	SGS / GS
Freehub	FH-M770 / FH-M775
Gears	10
Cassette sprocket	CS-M771-10
Chain	CN-HG94
Bottom bracket guide	SM-SP17 / SM-BT17

SHIMANO

SHIMANO AMERICAN CORPORATION
One Holland, Irvine, California 92618, U.S.A. Phone: +1-949-951-5003

SHIMANO EUROPE B.V.
Industrieweg 24, 8071 CT Nunspeet, The Netherlands Phone: +31-341-272222

SHIMANO INC.
3-77 Oimatsu-cho, Sakai-ku, Sakai-shi, Osaka 590-8577, Japan

* Service Instructions in further languages are available at : <http://techdocs.shimano.com>

Please note: specifications are subject to change for improvement without notice. (English)
© Feb. 2010 by Shimano Inc. XBC SZK Printed in Japan.

This service instruction explains how to use and maintain the Shimano bicycle parts which have been used on your new bicycle. For any questions regarding your bicycle or other matters which are not related to Shimano parts, please contact the place of purchase or the bicycle manufacturer.

Specifications

Rear Derailleur

Model number	RD-M773	
Type	SGS	GS
Gears	10	
Total capacity	43 T	35 T
Largest sprocket	36 T	36 T
Smallest sprocket	11 T	11 T
Front chainwheel tooth difference	18 T	

Cassette sprocket tooth combination

Model number	Group name	Gears	Tooth combination
CS-M771-10	bL	10	11, 12, 14, 16, 18, 20, 22, 25, 28, 32 T
	bJ	10	11, 13, 15, 17, 19, 21, 23, 26, 30, 34 T
	bK	10	11, 13, 15, 17, 19, 21, 24, 28, 32, 36 T

Freehub

Model number	FH-M770 / FH-M775
Gears	10
No. of spoke holes	36 / 32

These Service Instructions describe the operation method when using the RAPIDFIRE SL-M770 in combination with the RD-M773 top normal-type rear derailleur.

Gear shifting operation

This release lever is equipped with a 2-way release mechanism which allows release operations to be carried out by either pushing or pulling the lever.

Both lever (A) and lever (B) always return to the initial position when they are released after shifting. When operating one of the levers, always be sure to turn the crank arm at the same time.

To shift from a small sprocket to a larger sprocket (Lever A)

To shift one step only, press lever (A) to the (1) position. To shift two steps at one time, press to the (2) position.

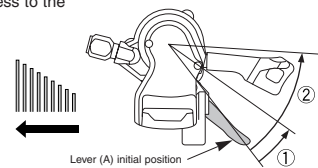

To shift from a large sprocket to a smaller sprocket (Lever B)

Press lever (B) once to shift one step from a larger to a smaller sprocket.

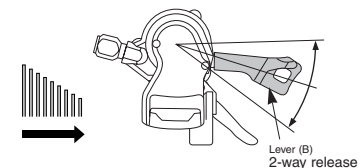

Installation of the sprockets

For each sprocket, the surface that has the group mark should face outward and be positioned so that the wider part of each sprocket and the A part (where the groove width is wide) of the freewheel body are aligned.

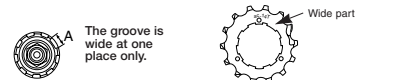

(bL) 11 - 32T
(bJ) 11 - 34T
(bK) 11 - 36T

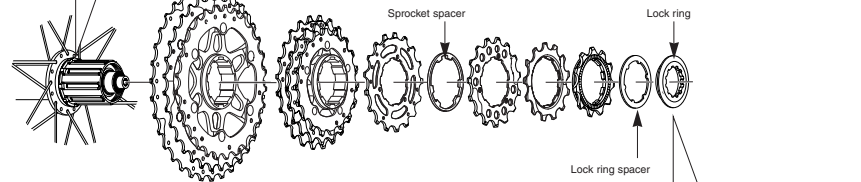

For installation of the HG sprockets, use the special tool (TL-LR15/LR10) to tighten the lock ring.

Tightening torque:
30 - 50 N·m (261 - 434 in. lbs.)

To replace the HG sprockets, use the special tool (TL-LR15/LR10) and TL-SR21 to remove the lock ring.

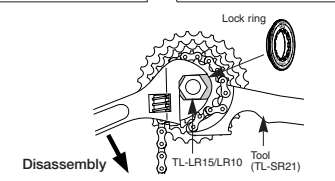

Chain length on bicycles with rear suspension

The length of A will vary depending on the movement of the rear suspension. Because of this, an excessive load may be placed on the drive system if the chain length is too short. Set the length of the chain by adding two links to the chain when the rear suspension is at a position where dimension "A" is longest and the chain is on the largest sprocket and the largest chainring. If the amount of movement of the rear suspension is large, the slack in the chain may not be taken up properly when the chain is on the smallest chainring and smallest sprocket.

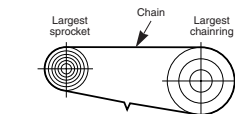
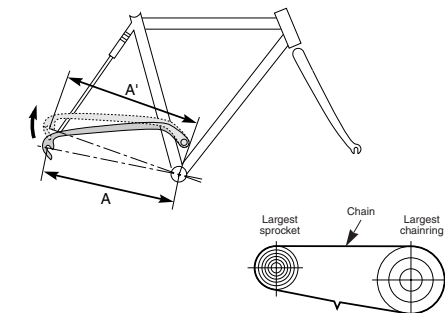

Add 2 links (with the chain on both the largest sprocket and the largest chainring)

Installation of the lever

Use a handlebar grip with a maximum outer diameter of 36 mm.

Tightening torque :
5 N·m (44 in. lbs.)



If not using the indicator, this shifting lever can be installed either on the inside or the outside of the brake lever. If adjusting the position, remove the indicator, and then be sure to secure it in the new position with the two fixing bolts.

Tightening torque :
2.5 N·m (22 in. lbs.)

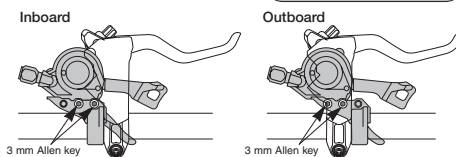

- Install the shifting lever in a position where it will not obstruct brake operation and gear shifting operation.
- Do not use in a combination which causes brake operation to be obstructed.
- When installing the components to carbon frame/handle bar surfaces, verify with the manufacturer of the carbon frame/parts for their recommendation on tightening torque in order to prevent over tightening that can cause damage to the carbon material and/or under tightening that can cause lack of fixing strength for the components.

Refer to the RD-M773 (Rear Derailleur) Service Instructions for details on installing the rear derailleur and SIS adjustment.

Connection and securing of the inner cable

Operate lever (B) nine times or more, and check on the indicator that the lever is at the highest position. Then remove the inner hole cover and connect the inner cable.

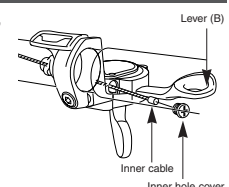

Install the inner hole cover by turning it as shown in the illustration until it stops. Do not turn it any further than this, otherwise it may damage the screw thread.

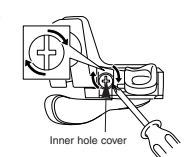

Cutting the outer casing

When cutting the outer casing, cut the opposite end to the end with the marking. After cutting the outer casing, make the end round so that the inside of the hole has a uniform diameter.

Attach the same outer end cap to the cut end of the outer casing.

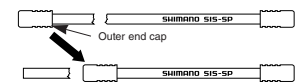

The sealed cap with tongue and the rubber shield should be installed to the outer casing stopper of the frame.

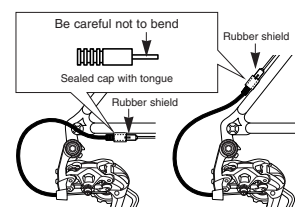

* If the rear derailleur moves to a large degree, such as in bicycles with rear suspension, it is recommended that you replace the cap with an aluminum cap. The end of the outer casing which has the aluminum cap should be at the derailleur side.

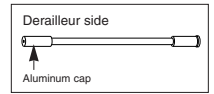

Replacement of the freewheel body

First, pull out the hub axle by following the procedure shown in the illustration.

The double-lock section at the freewheel side cannot be disassembled.

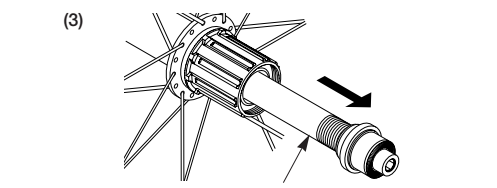
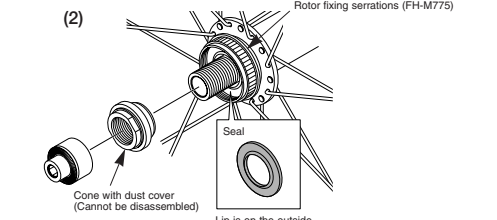
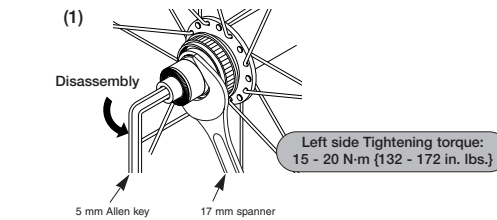

Note:

- When removing and installing the seal, do it very carefully so that the seal does not become bent. When reinstalling the seal, make sure that it is facing the right way, and insert it as far as it will go.
- Do not disassemble the dust cover which is crimped onto the cone.
- The rotor fixing serrations may become damaged if the disc brake rotor has not been installed to the FH-M775, so install the accessory rotor mount cover.

After removing the hub axle, remove the freewheel body fixing bolt (inside the freewheel body), and then replace the freewheel body.

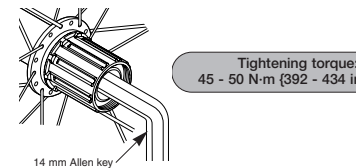
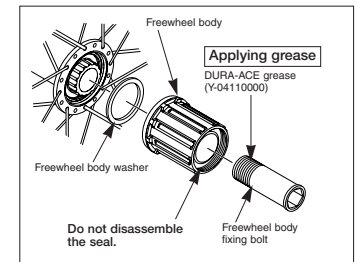

Tightening torque:
45 - 50 N·m (392 - 434 in. lbs.)

Note:

When replacing the freewheel body, replace the freewheel body fixing bolt at the same time. Be sure to apply grease to the thread of the freewheel body fixing bolt, otherwise looseness or sticking may occur. Do not attempt to disassemble the freewheel body, because it may result in a malfunction.

Replacing and installing the indicator

Disassembly and reassembly should only be carried out when removing or replacing the indicator. For the front, the needle is in the opposite position.

[Removal]

1. Operate lever B nine times or more to set the lever to the top position.
2. Remove the two indicator fixing screws which are securing the indicator.
3. Lift up the lens as shown in the illustration, and then disengage the hooked part and remove the indicator unit.

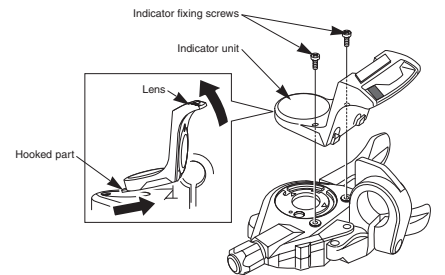

[Installation]

1. Operate lever B nine times or more to set the lever to the top position.
2. Check that the indicator needle is pointing to the left, and align the pin at the bottom of the indicator and the boss on the indicator with the Δ marks on the shifting lever unit. Then insert the indicator into the shifting lever unit as shown in the illustration, starting with the boss and then followed by the pin in the reverse order to removal.
3. Tighten the two indicator fixing screws.
4. Check the operation of the indicator. If it does not operate correctly, reinstall it while paying particular attention to steps 1 and 2.

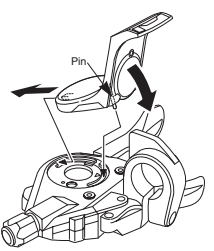

Tightening torque :
0.2 N·m (1 in. lbs.)

<If not installing the indicator>

1. Remove the indicator bracket protective cover which is attached to the indicator, starting from the shorter tab as shown in the illustration.
2. First insert the tab of the indicator bracket protective cover into the slot which does not have a Δ mark, and then set it onto the shifting lever unit and secure it with the indicator fixing screw.

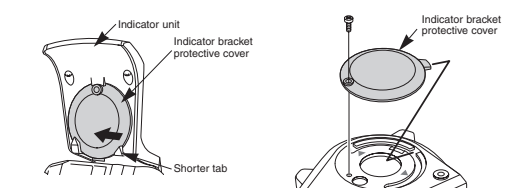

Tightening torque :
0.2 N·m (1 in. lbs.)

